

1

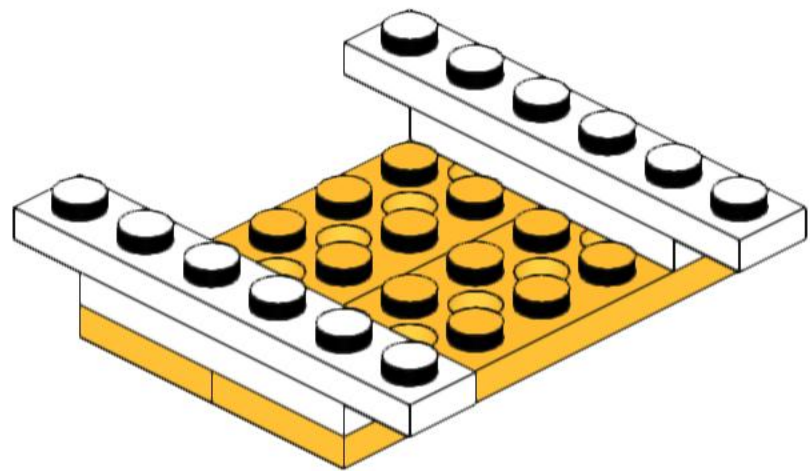

2

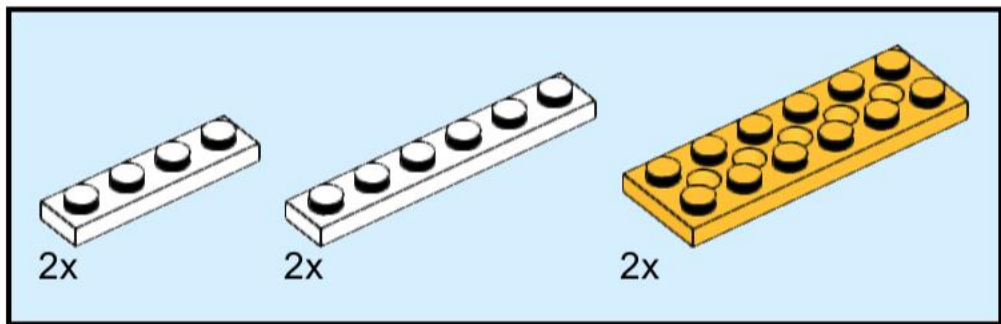
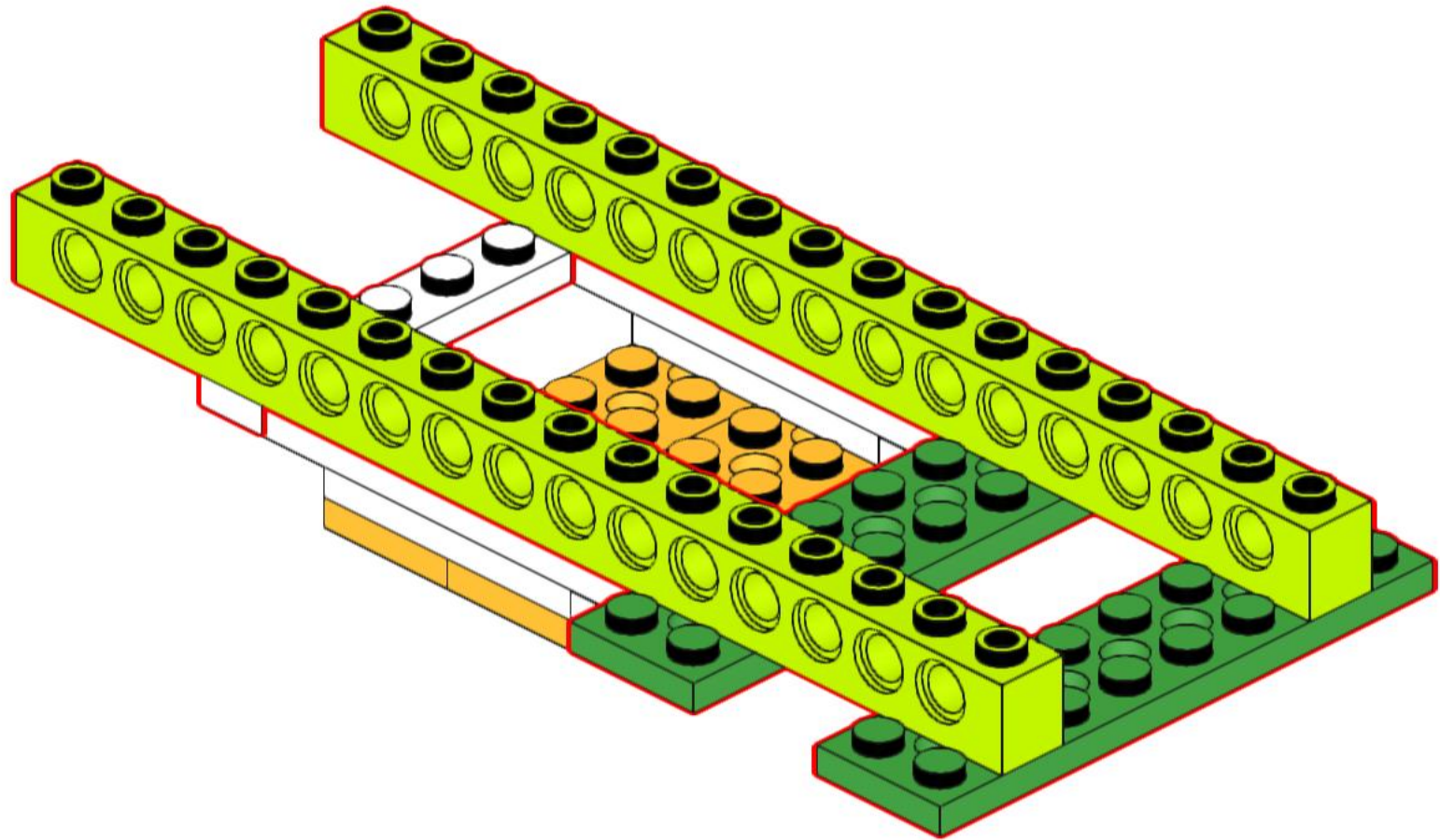
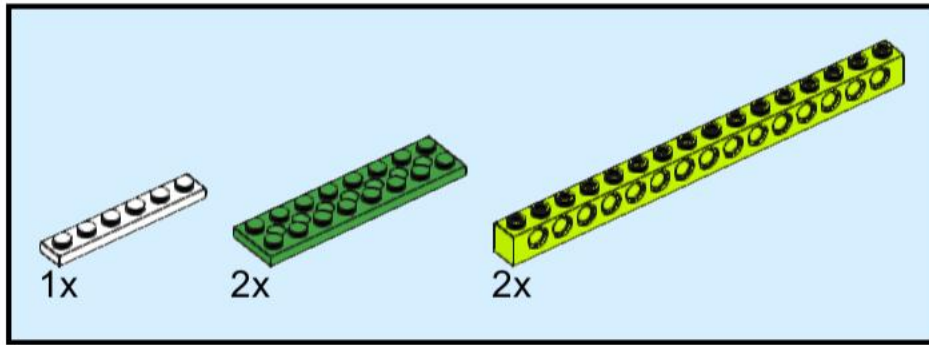

3

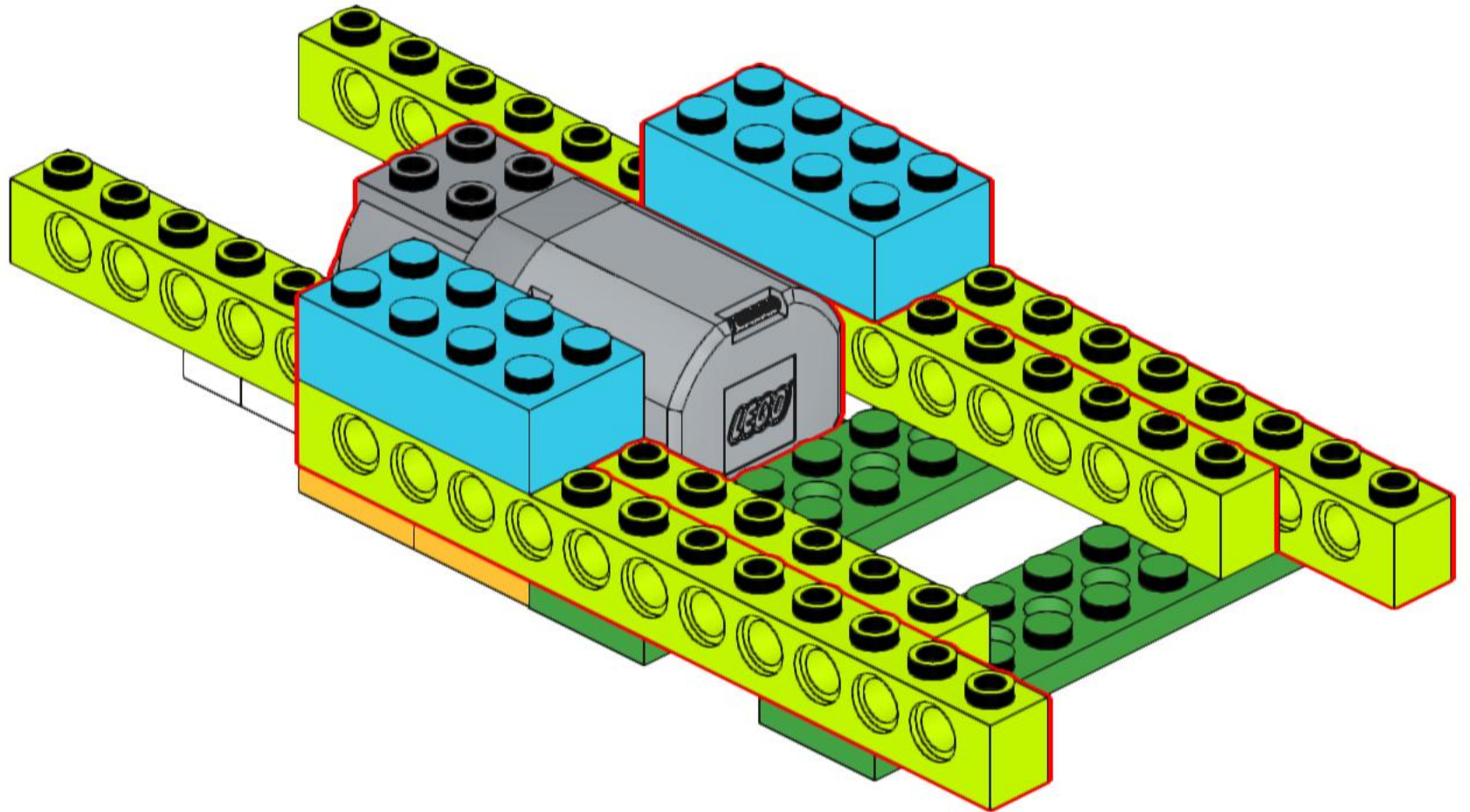
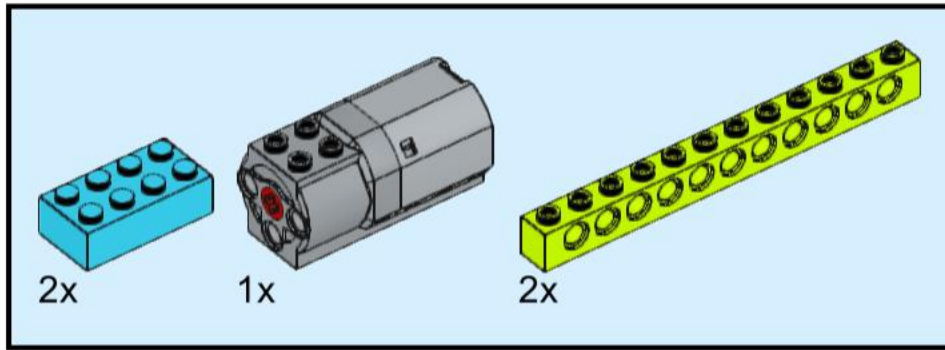

4

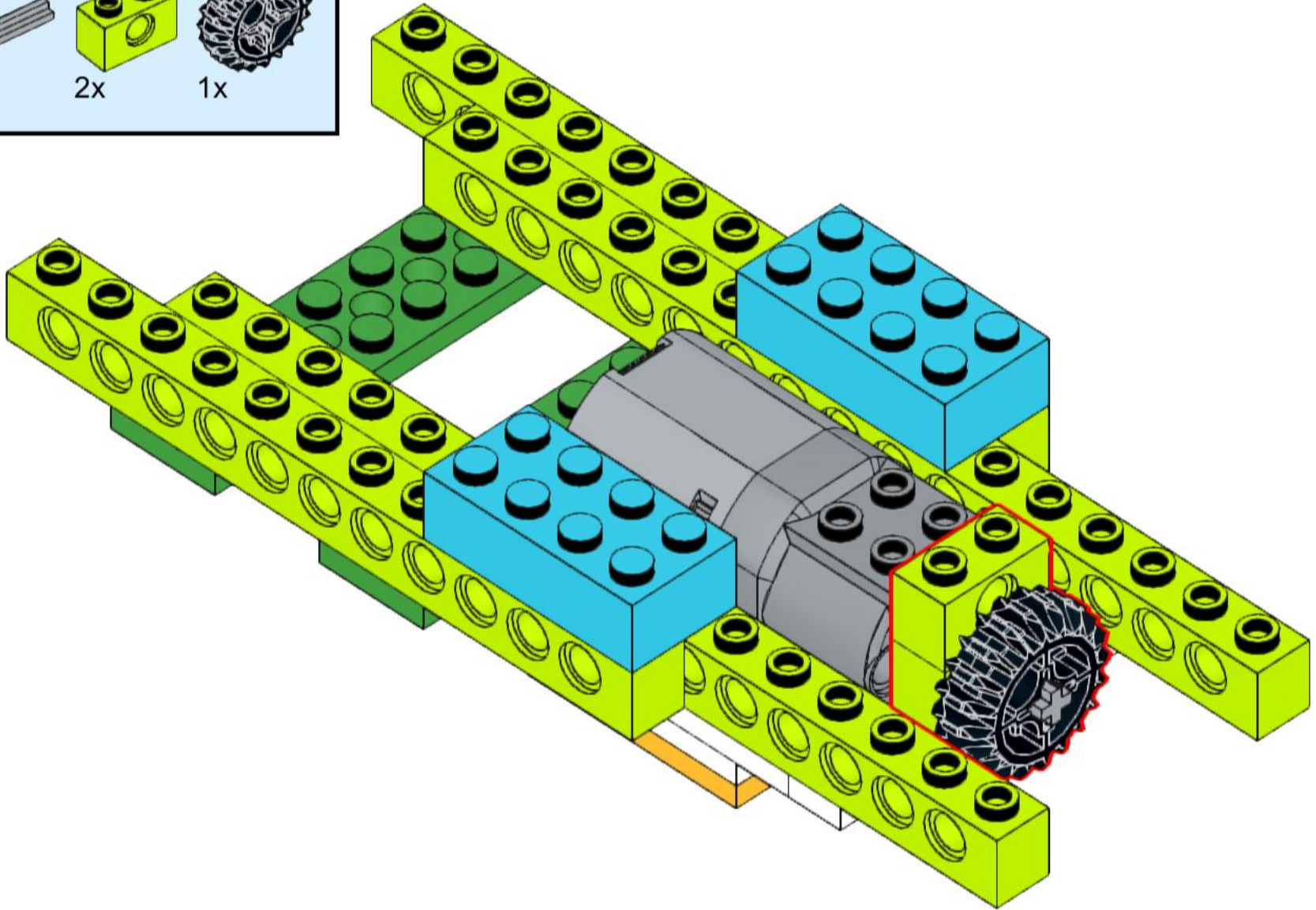
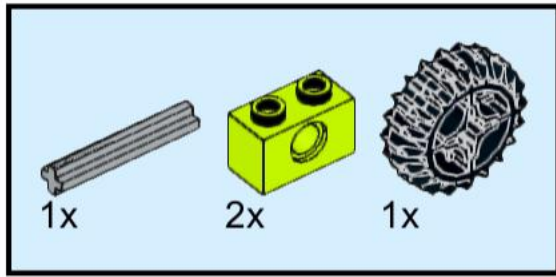



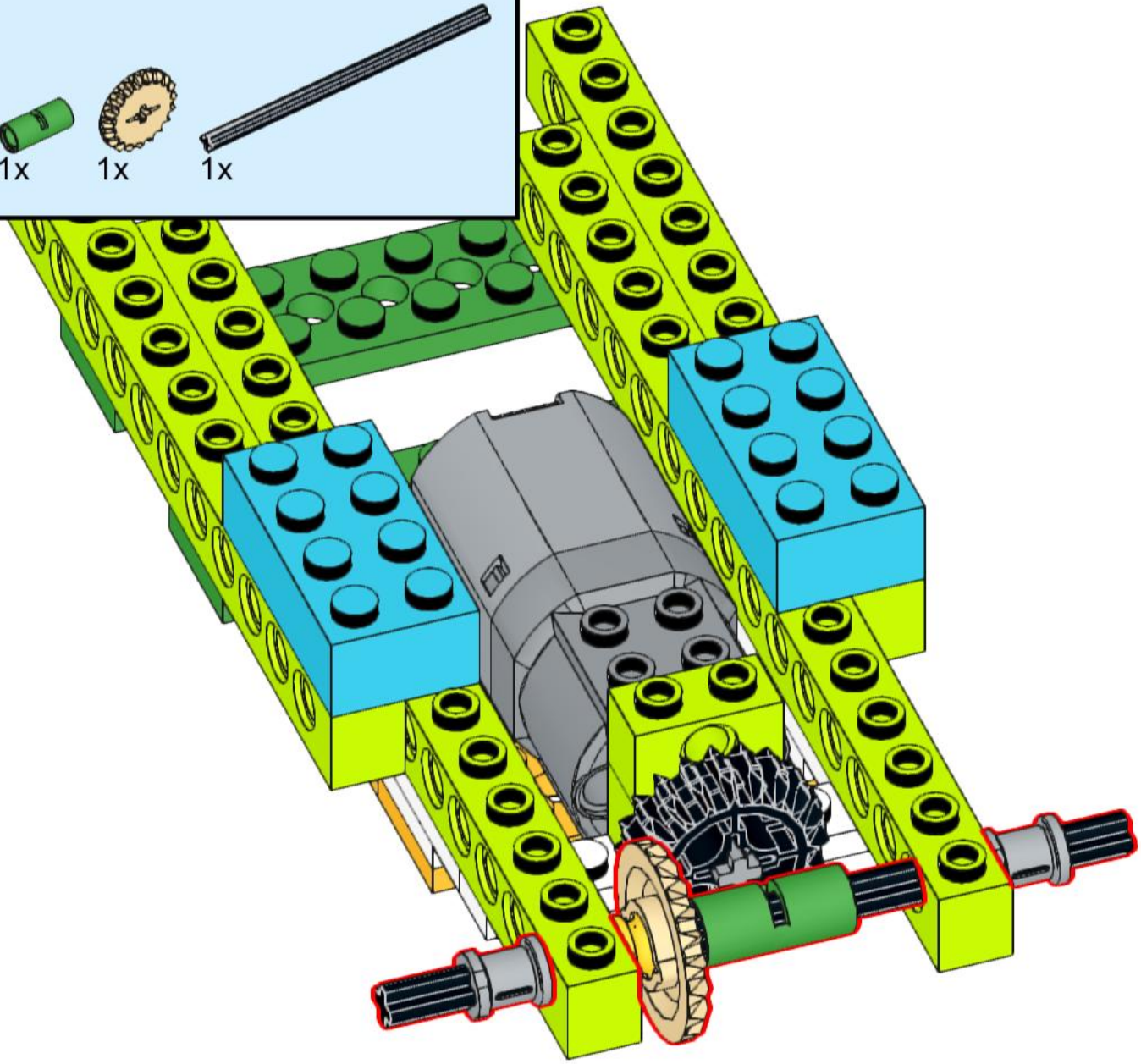
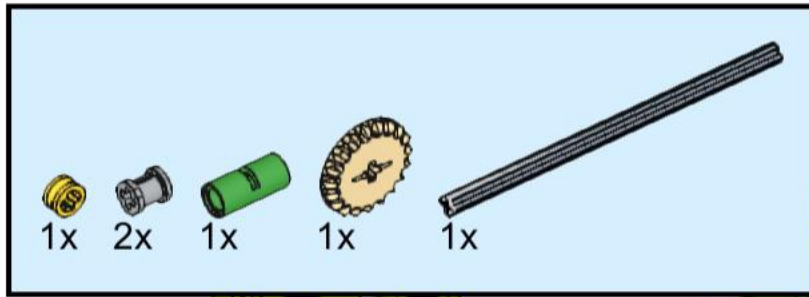

5

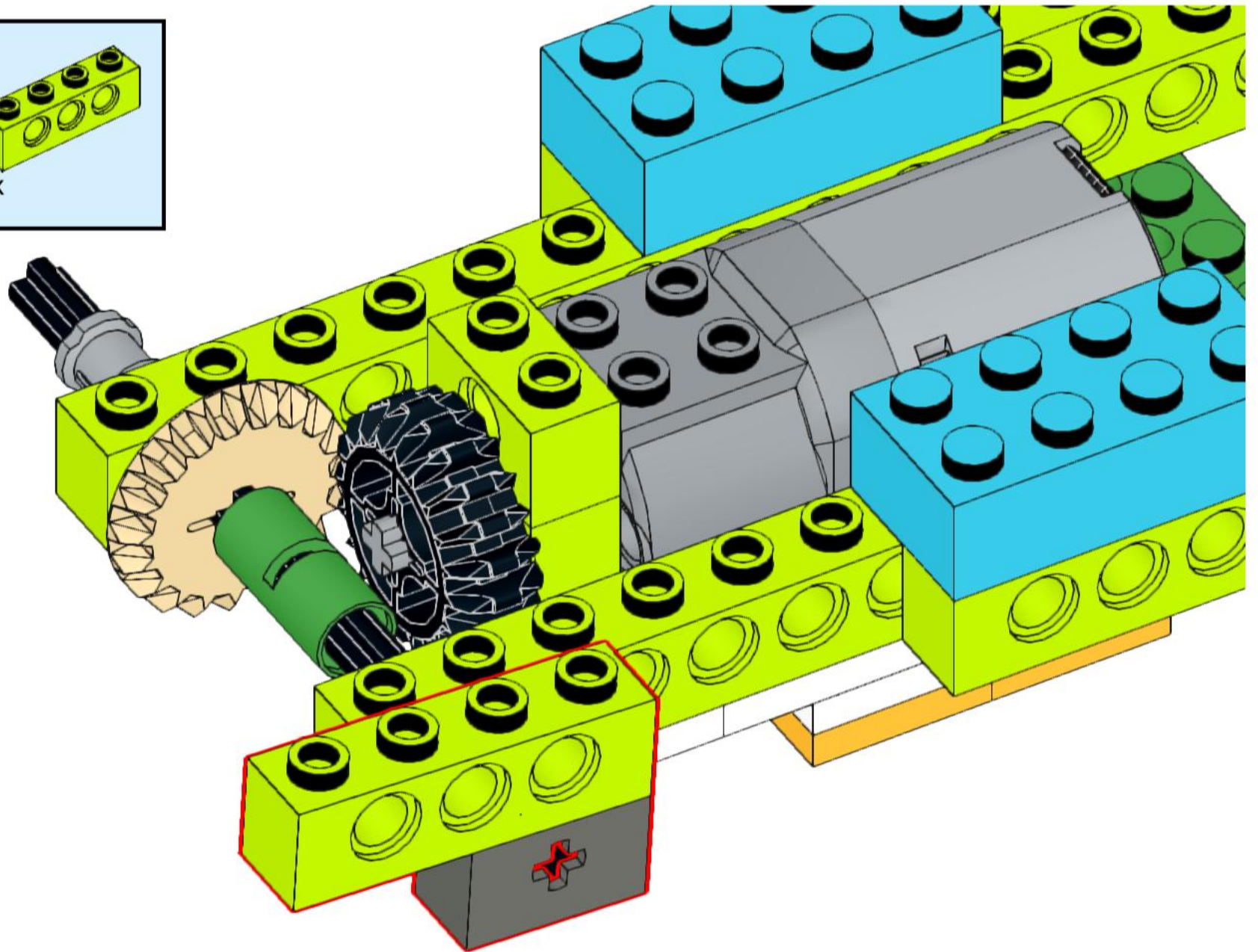
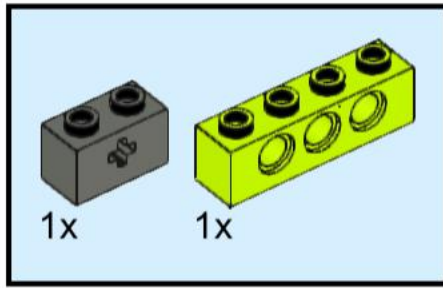

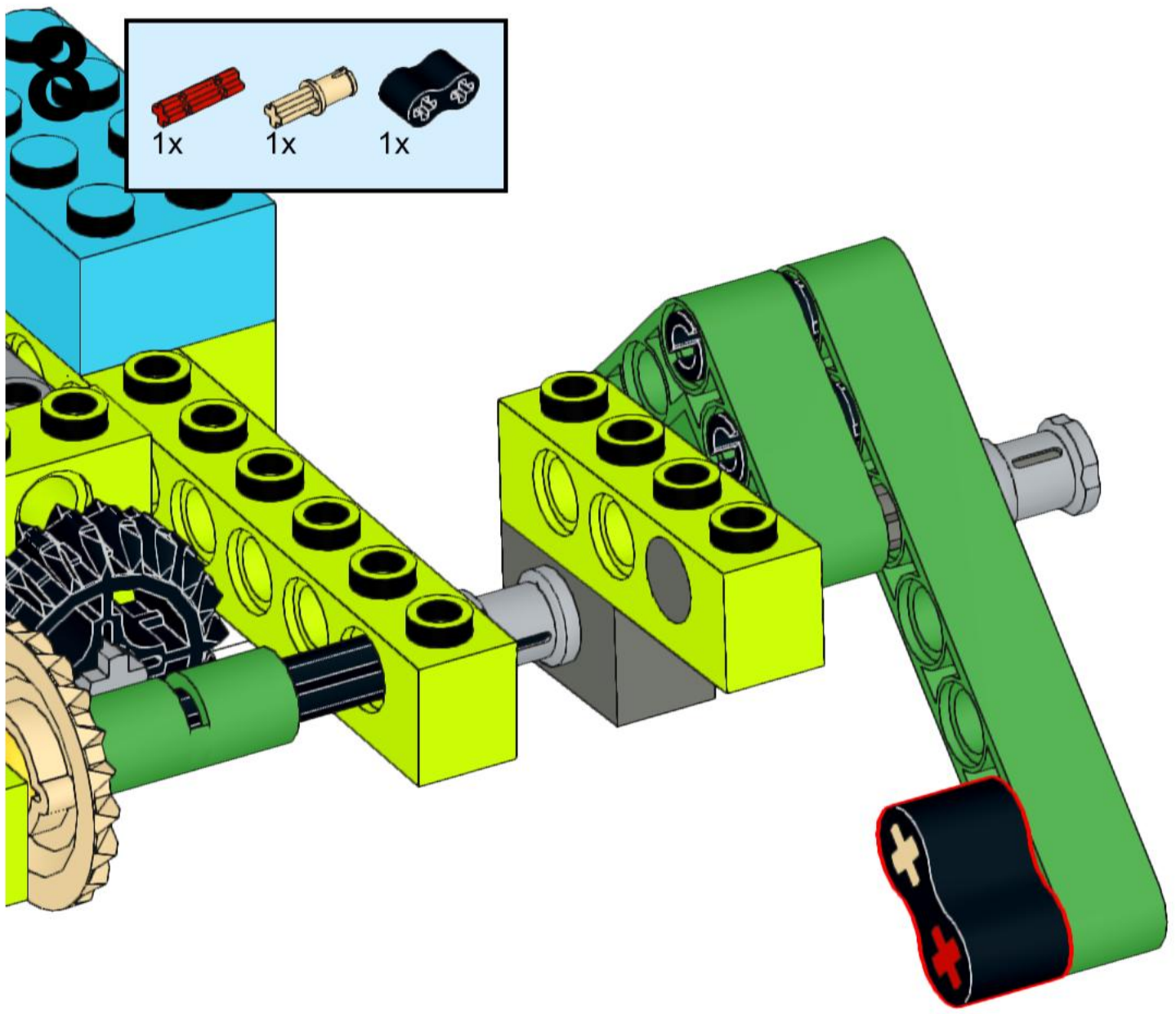
6





- 1x 
- 1x 
- 1x 

9

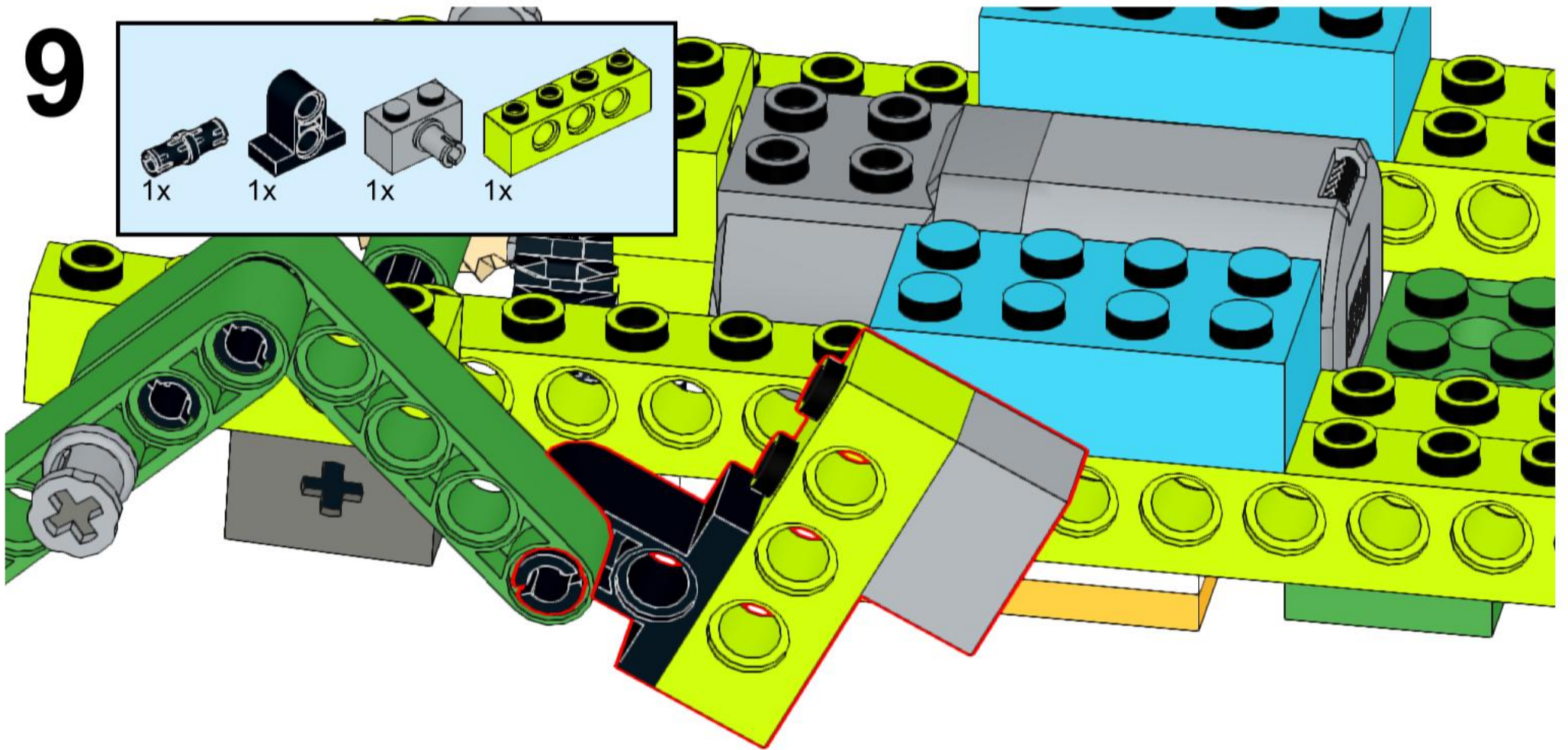
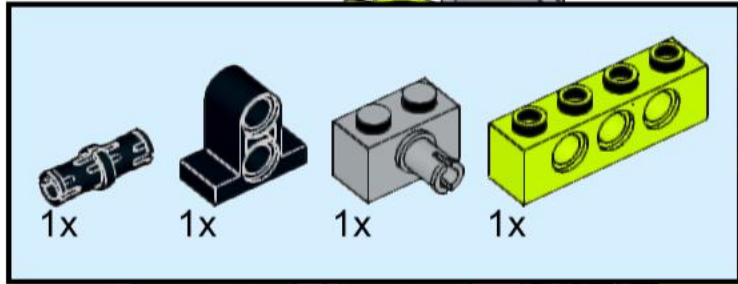

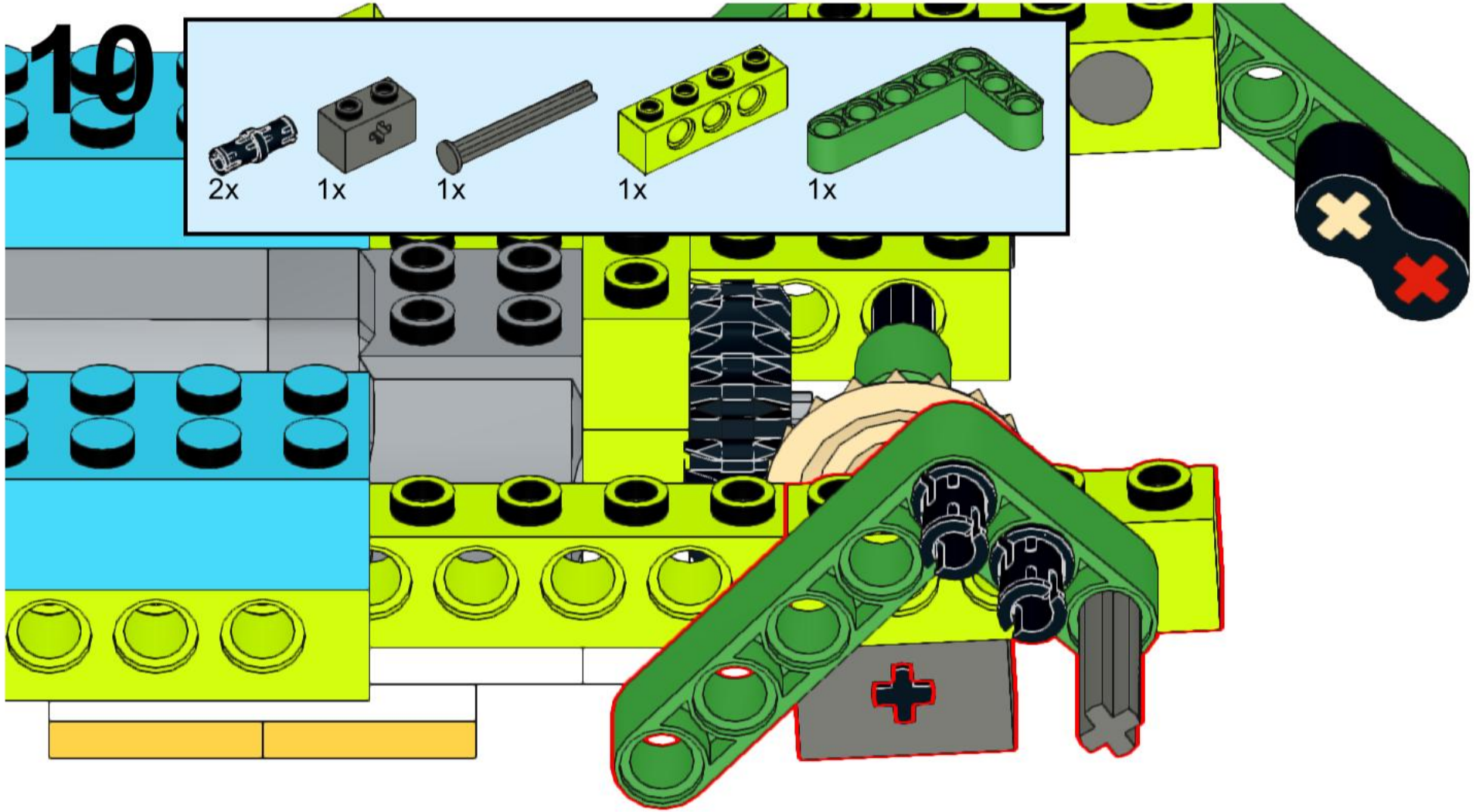



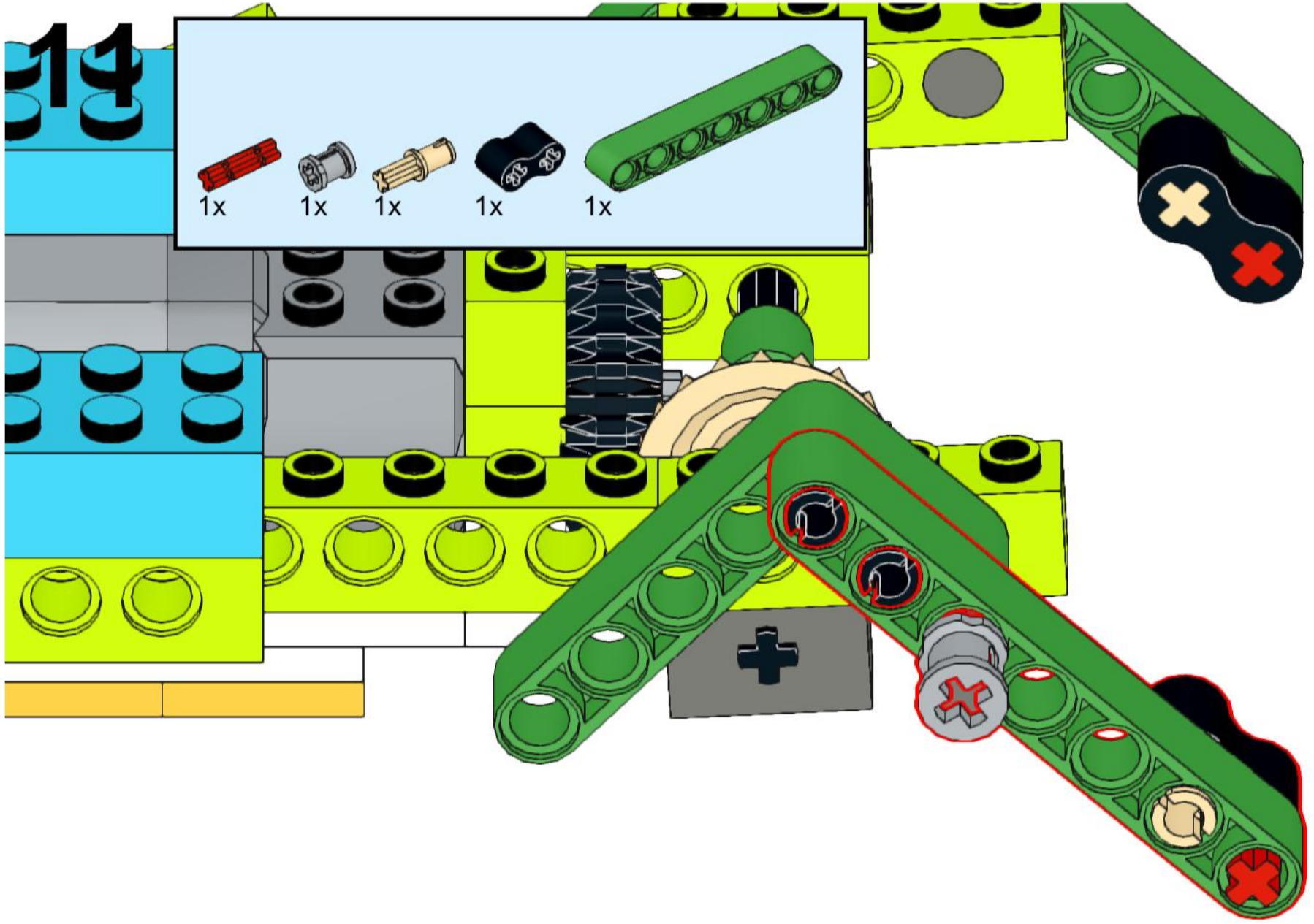

10

- 2x [Black Pin]
- 1x [Grey 2-hole Brick]
- 1x [Grey Axle]
- 1x [Yellow 1x4 Brick]
- 1x [Green L-shaped Technic Beam]

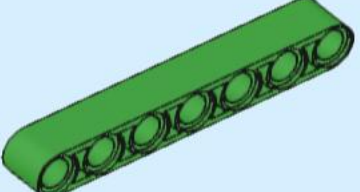

14

- 1x 
- 1x 
- 1x 
- 1x 
- 1x 



12

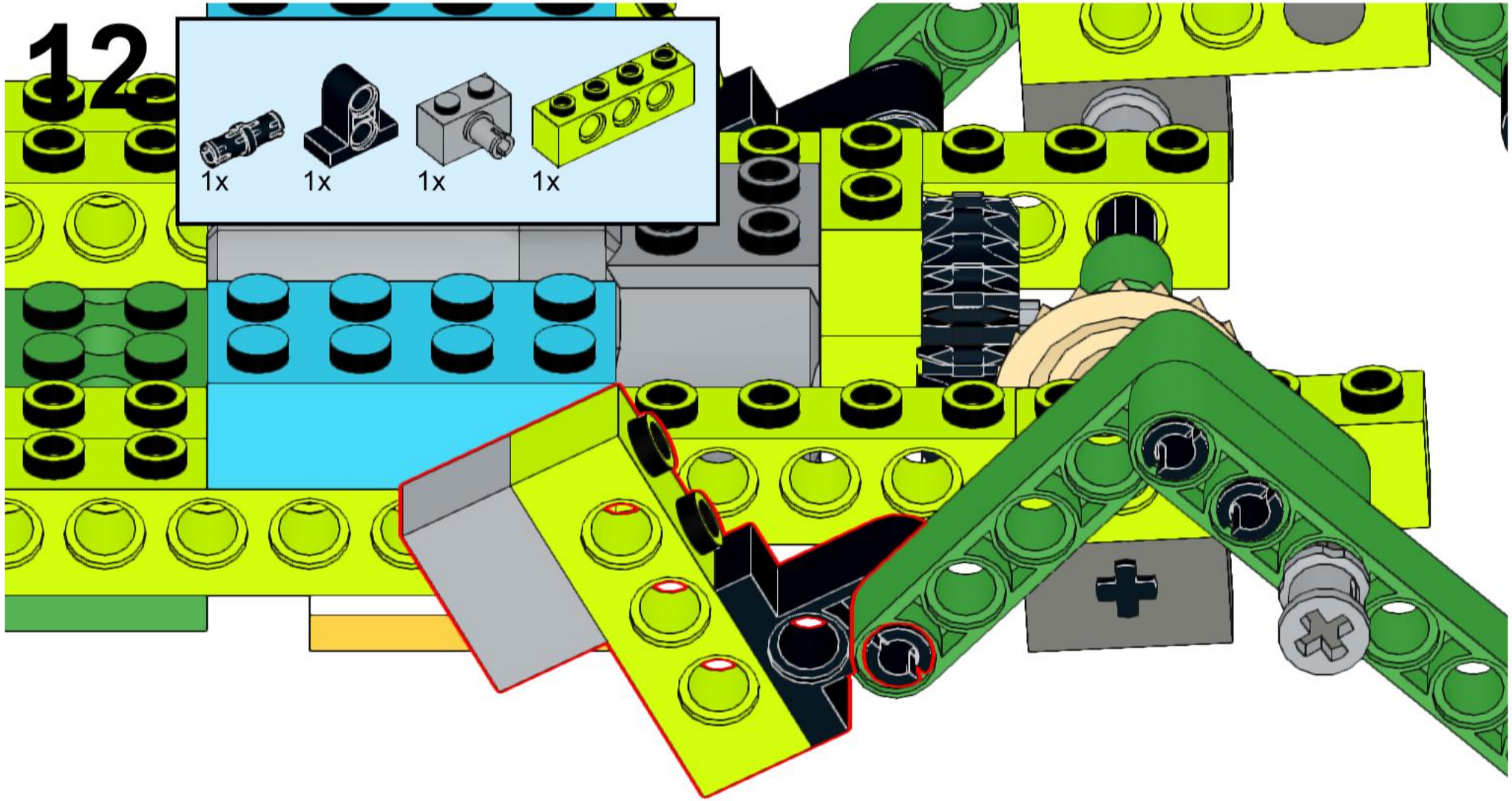
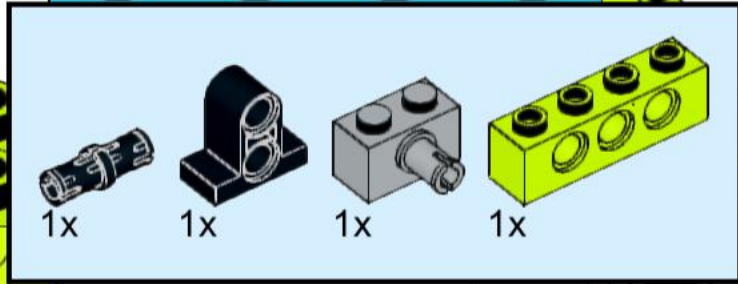

13

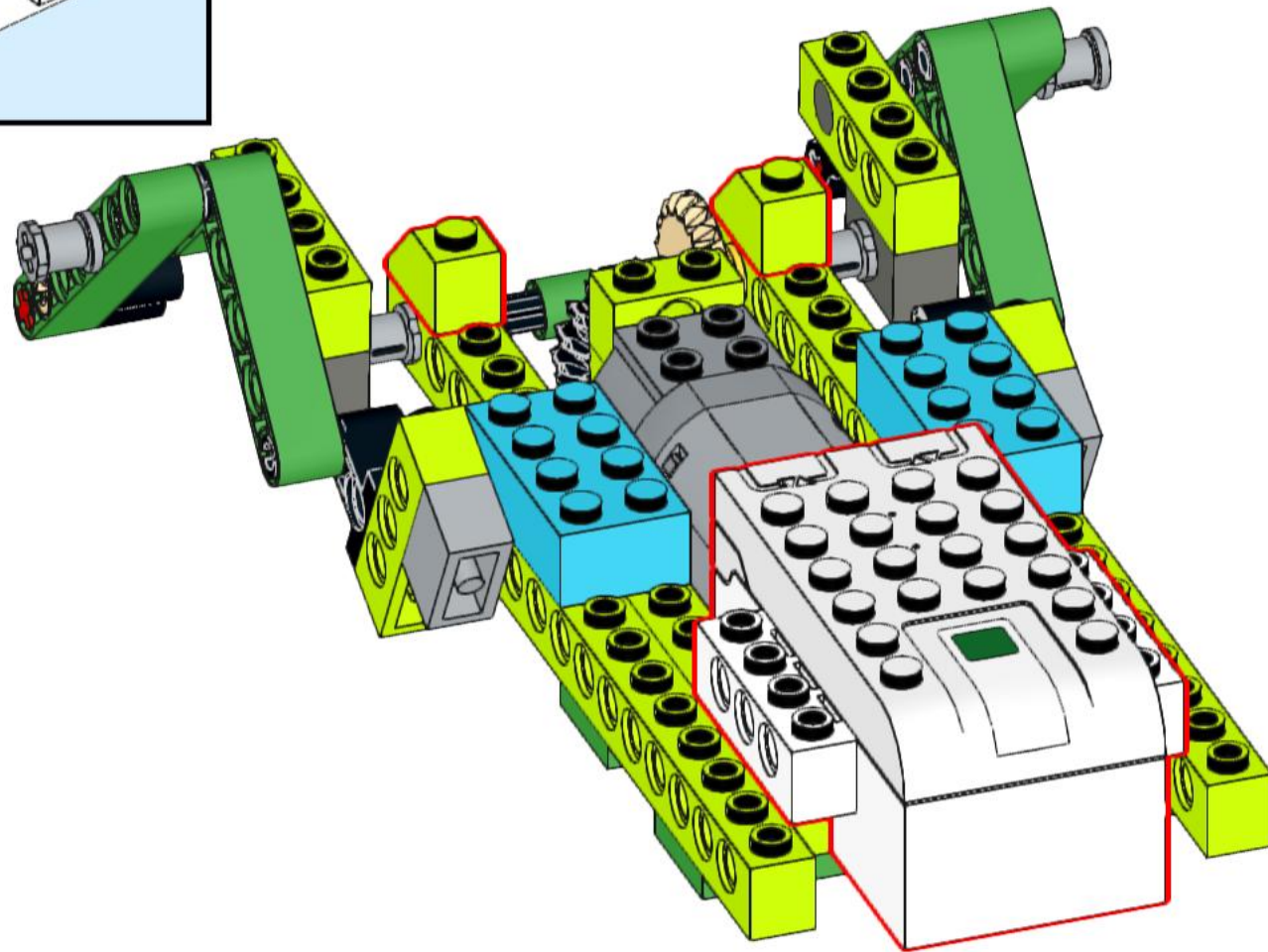
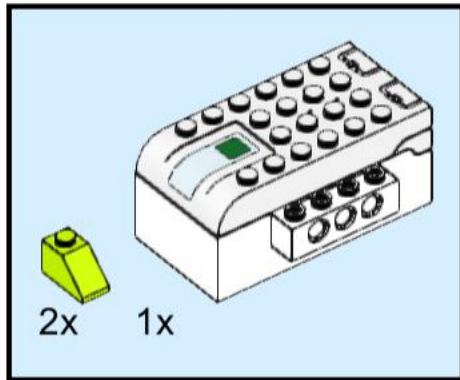

14

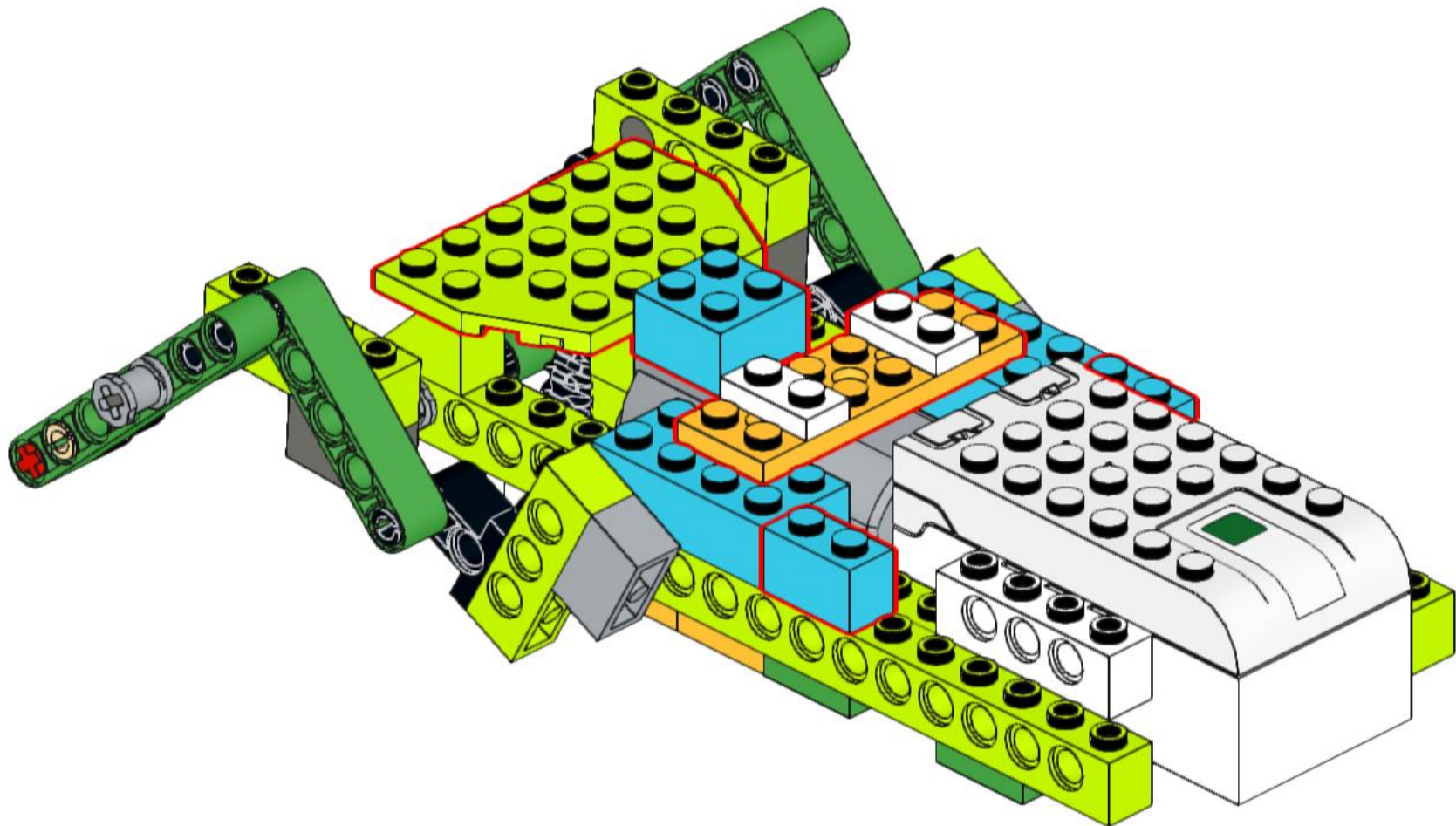
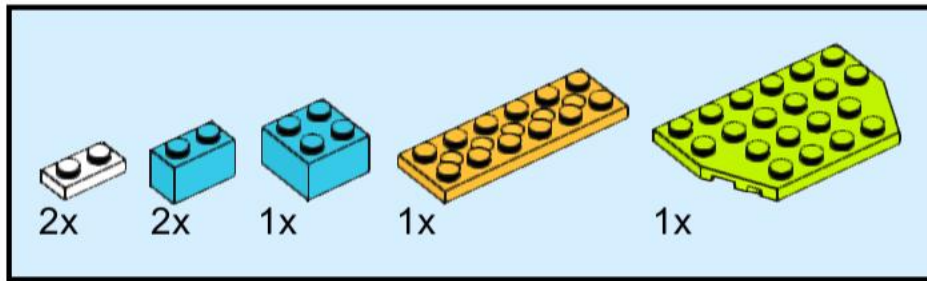

15

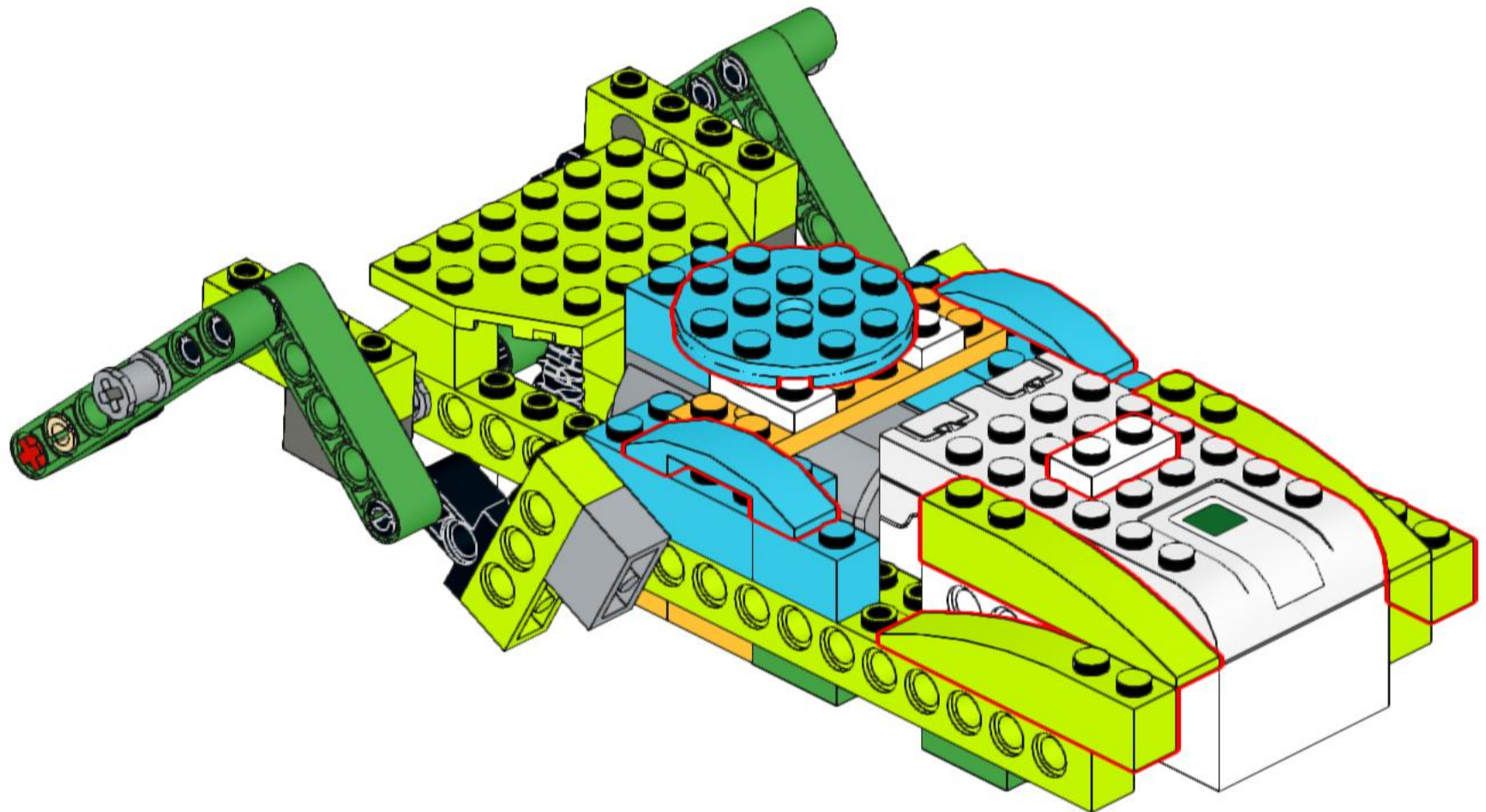
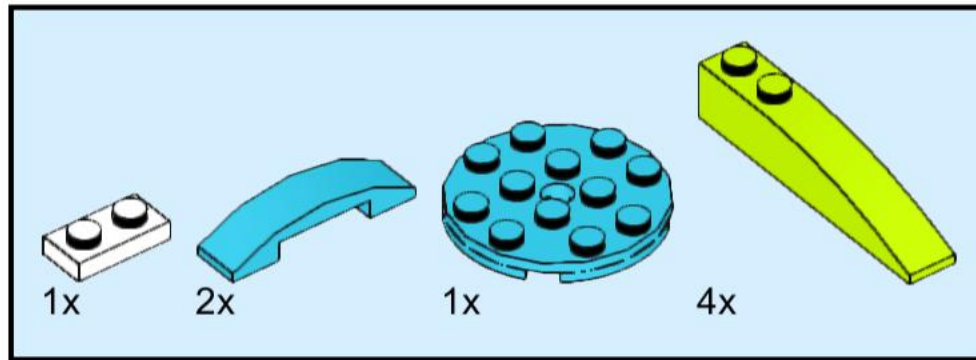

16

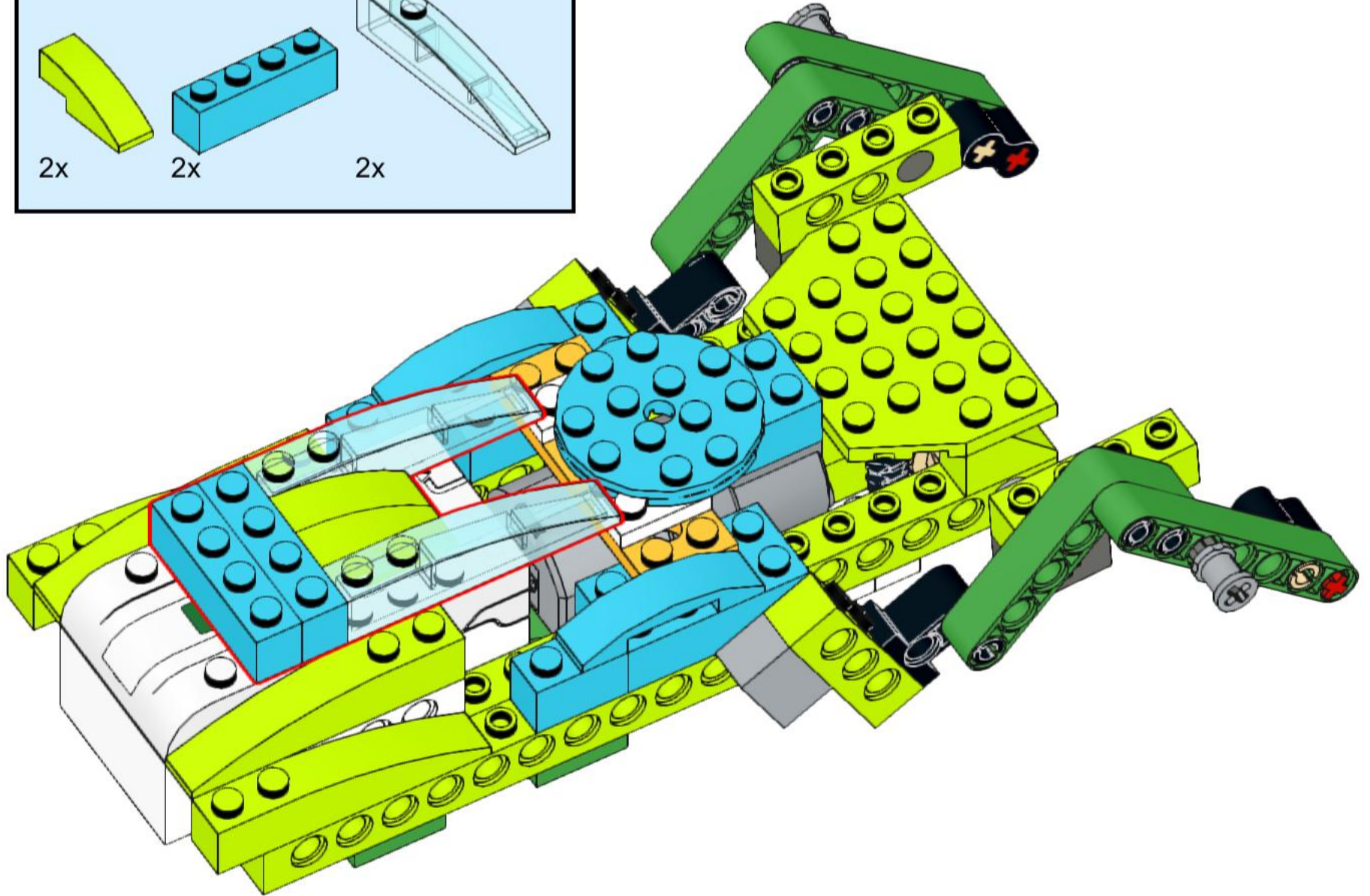
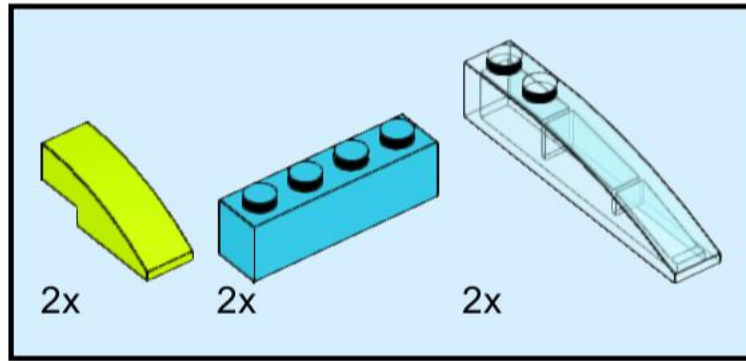

17

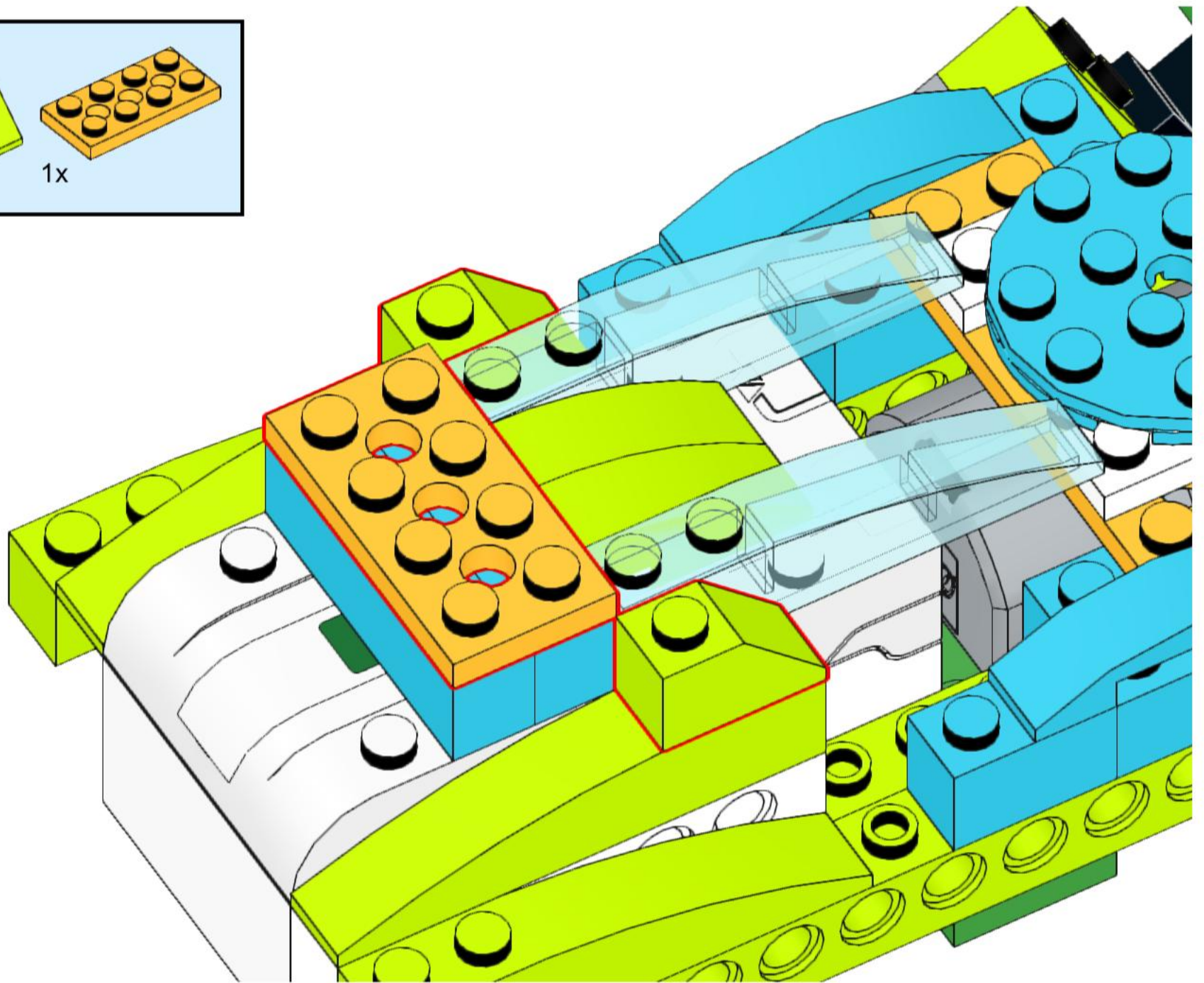
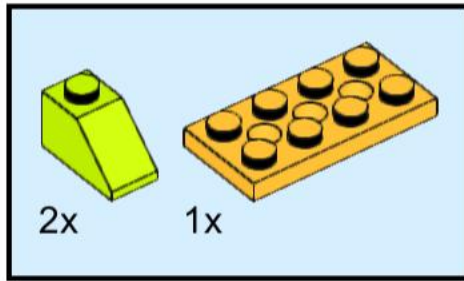

18

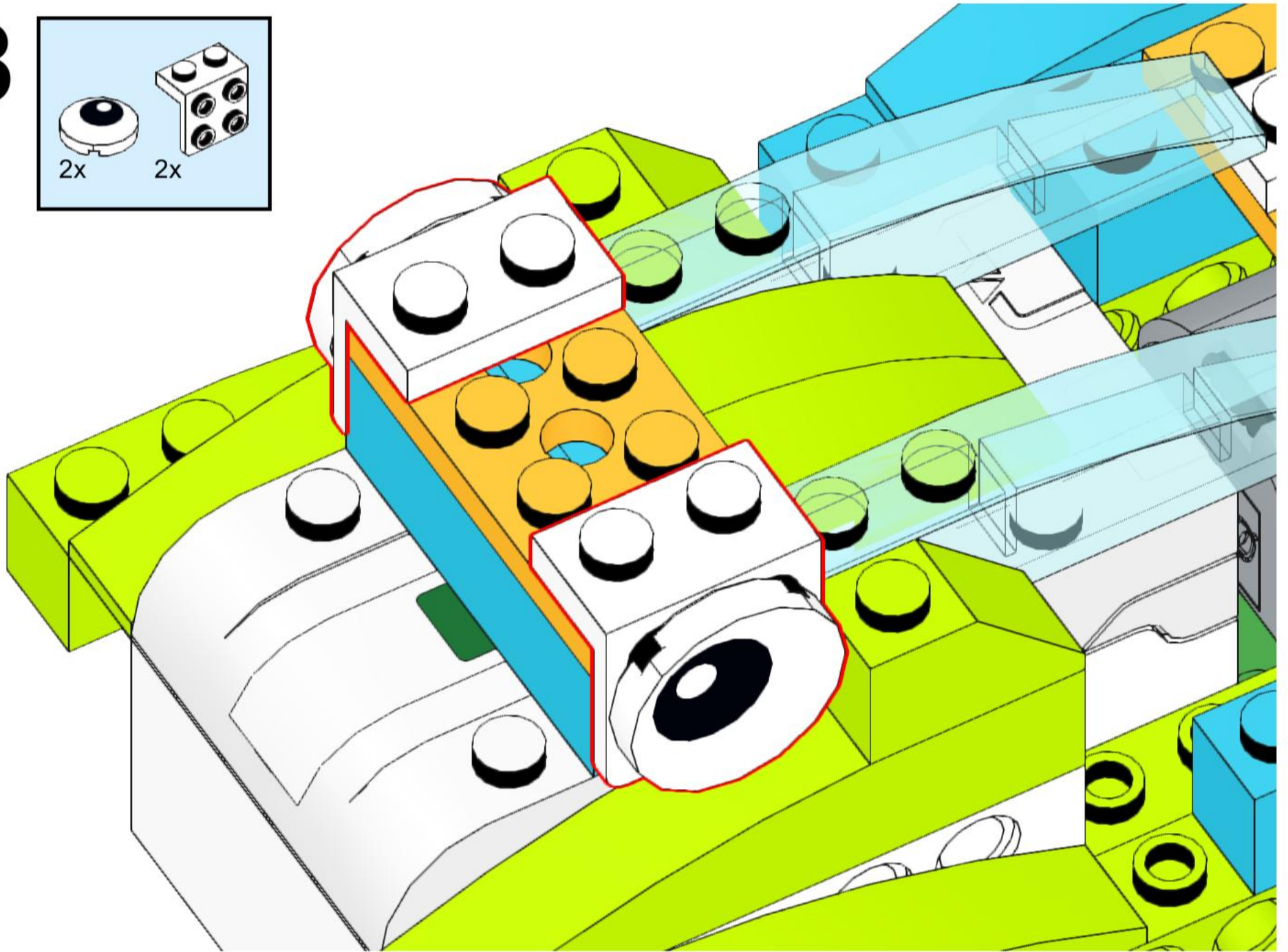
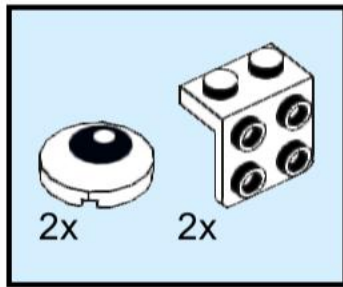

19

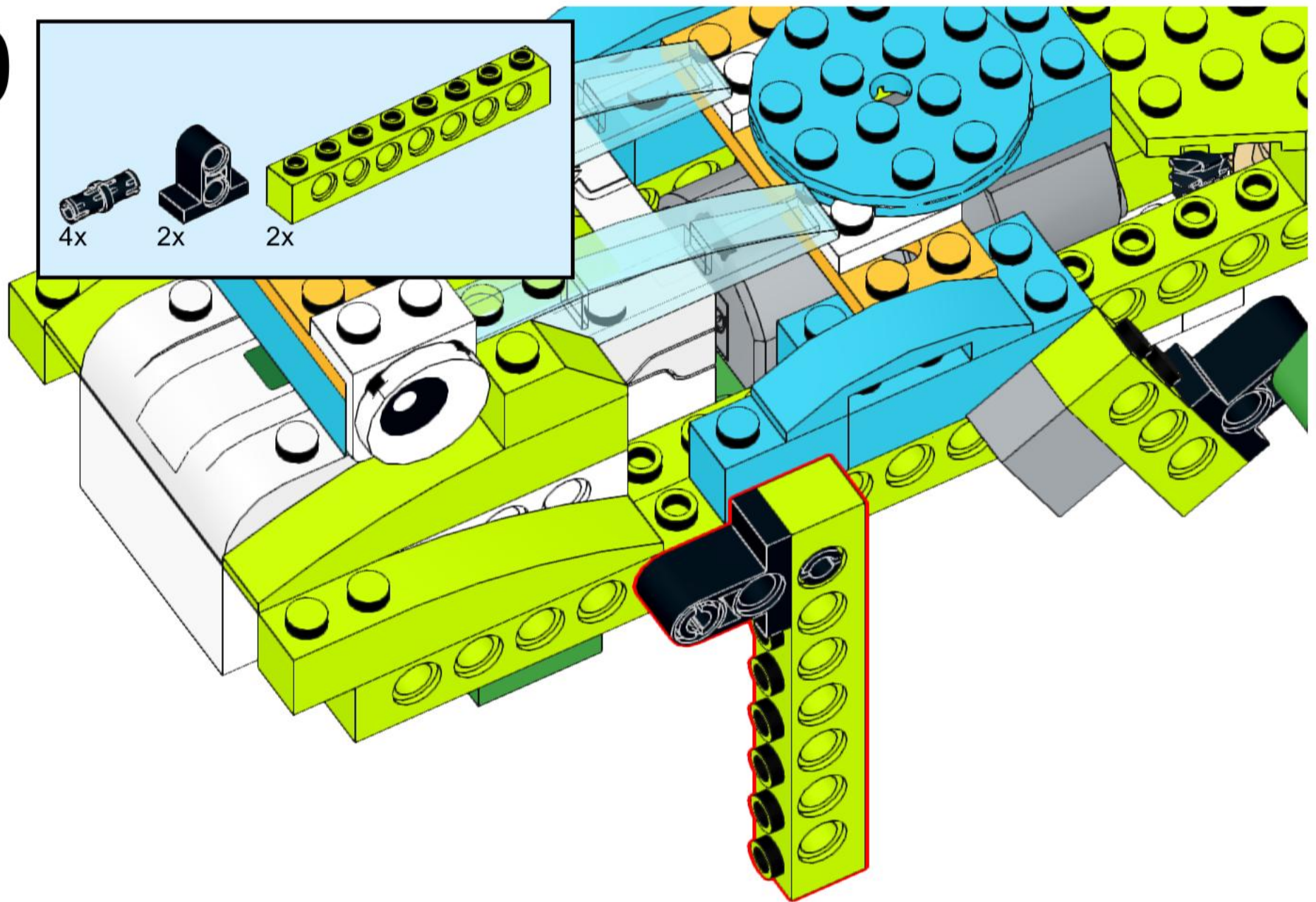

20

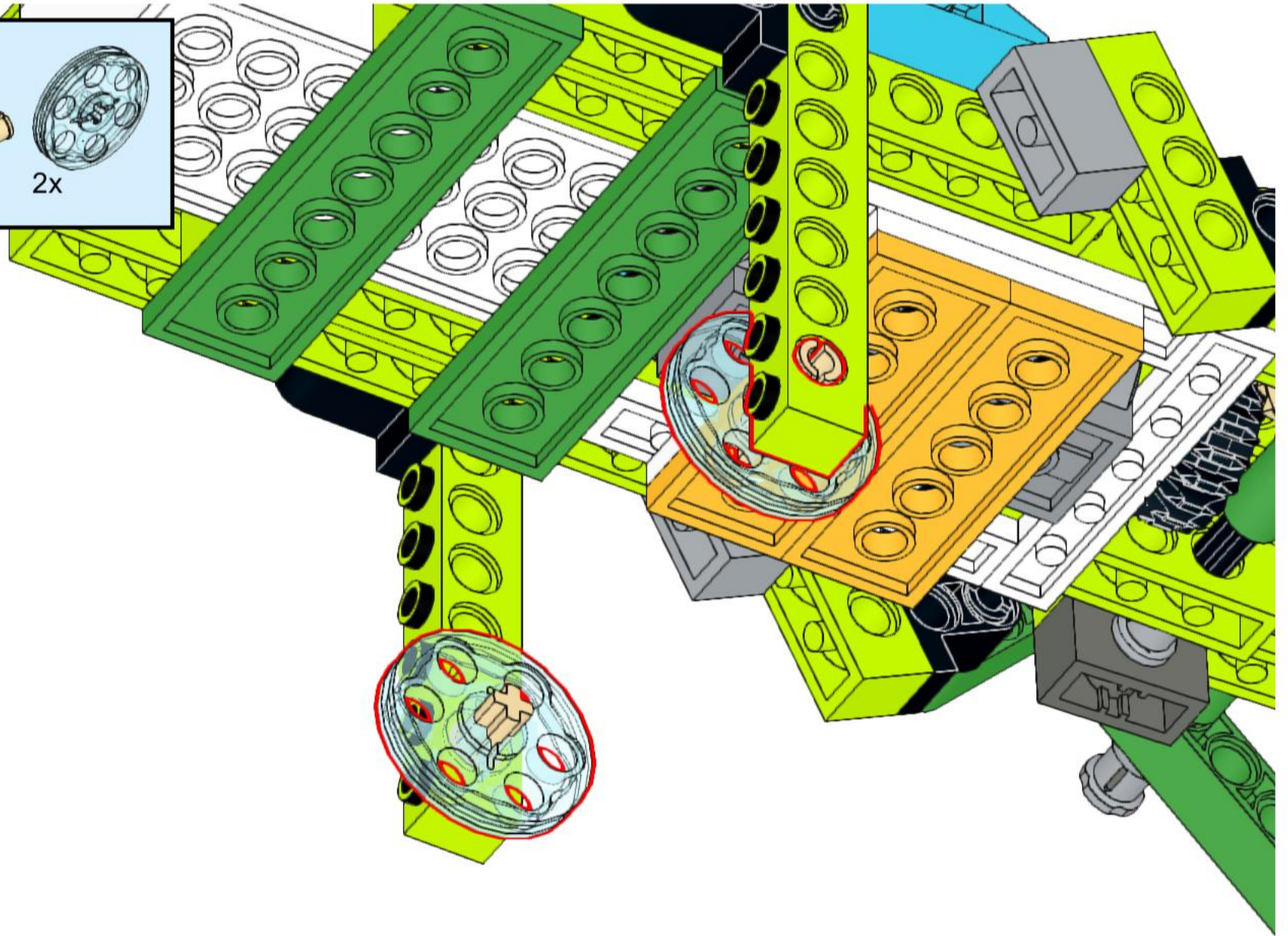
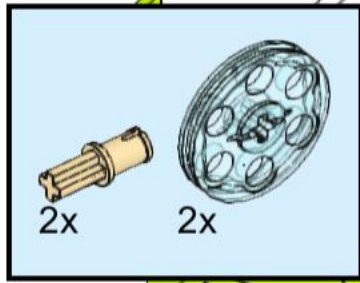

21

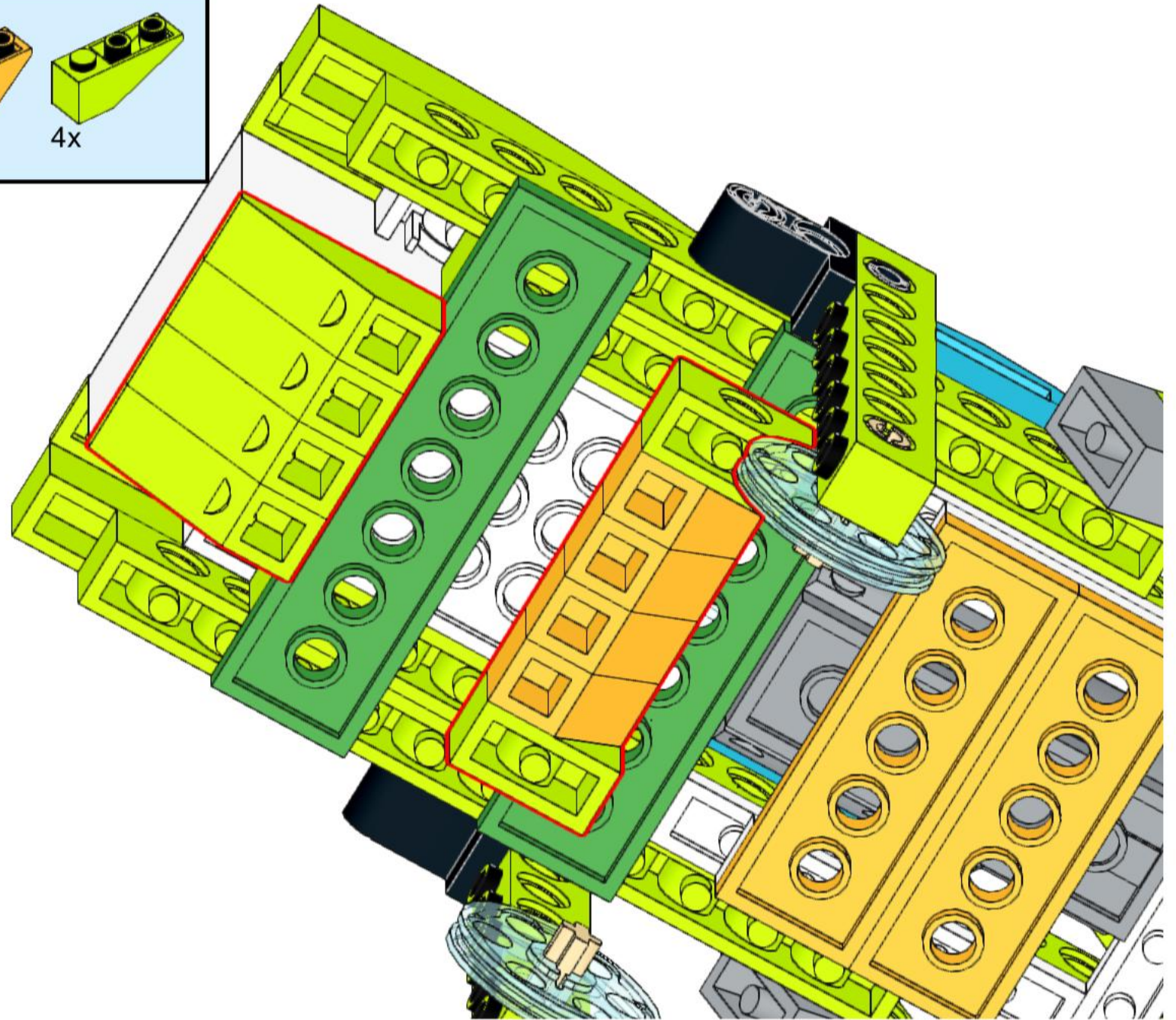
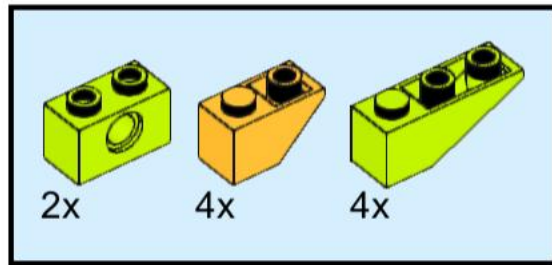

22

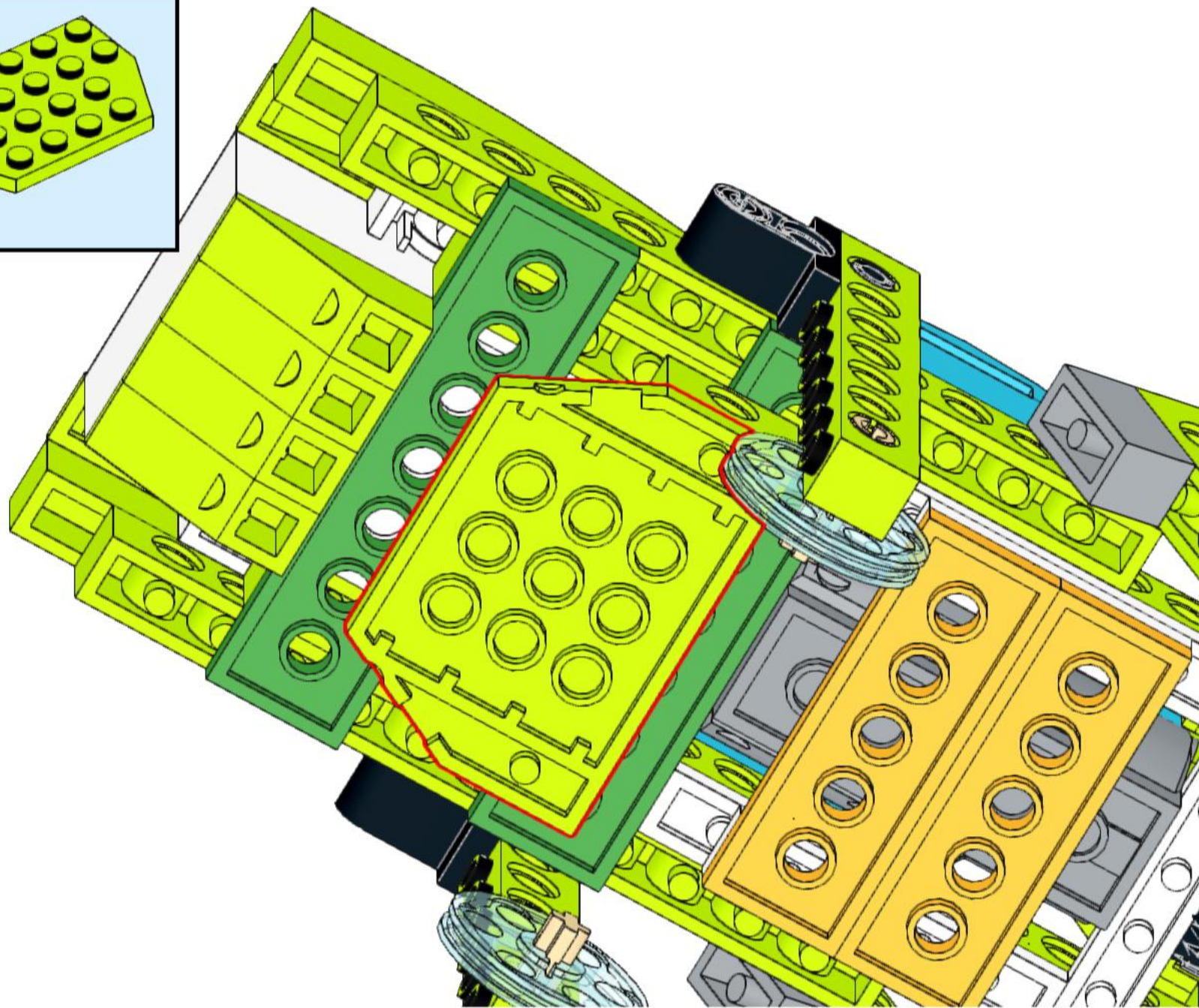
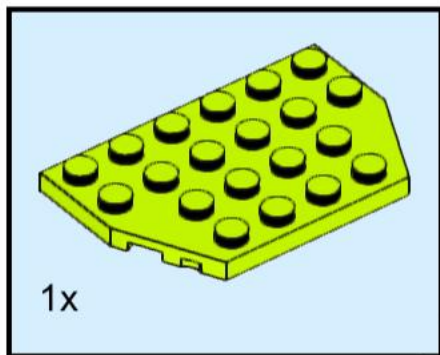

23

